

**RITM OKB ZAO**

**TRANSDERMAL ELECTRONEUROSTIMULATOR**

**RITMSCENAR Super Pro v.2**

**OPERATING MANUAL**



**MANUFACTURER**

RITM OKB ZAO

99, Petrovskaya str., Taganrog, Russia, 347900

Tel/Fax: +7 (8634) 62-31-79

www.scenar.com.ru e-mail: medsc@scenar.com.ru

**AUTHORIZED REPRESENTATIVE**

SCENAR Center – Bulgaria Ltd.

9, V. Aprilov blvd. Plovdiv, 4002, Bulgaria

phone: (+3-59-32) 641-001 e-mail: office@bgscenar.org

**IMPORTANT INFORMATION!****PLEASE READ THIS PAGE CAREFULLY**

**WARNING!** This device should NOT be used on an individual who has a heart pacemaker or other electrically powered implant fitted.

**WARNING!** Application of electrodes near the thorax may increase the risk of cardiac fibrillation.

**WARNING!** Simultaneous connection of a patient to a h.f. surgical equipment may result in burns at the site of the stimulator electrodes and possible damage to the stimulator.

**WARNING!** Operation in close proximity (e.g. 1 m) to a shortwave or microwave therapy equipment and mobile communicators may produce instability in the stimulator output.

**WARNING!** Aged people, children, and people with disabilities may not use the stimulator.

**WARNING!** The device needs special precautions regarding EMC and needs to be installed and put into service according to the EMC information provided in Annex 1.

**WARNING!** As the current densities for electrodes exceeds 2 mA r.m.s./cm<sup>2</sup>, the device requires the special attention of the user.

**WARNING!** The device should not be used adjacent to or stacked with other equipment.

This appliance is marked according to the European directive 2002/96/EC on Waste Electrical and Electronic Equipment (WEEE). By ensuring this product is disposed of correctly, you will help prevent potential negative consequences for the environment and human health, which could otherwise be caused by inappropriate waste handling of this product.

The symbol  on the documents accompanying the product, indicates that this appliance may not be treated as household waste. Instead it shall be handed over to the applicable collection point for the recycling of electrical and electronic equipment.

Disposal must be carried out in accordance with local environmental regulations for waste disposal.

For more detailed information about treatment, recovery and recycling of this product, please contact your local city office, your household waste disposal service or the shop where you purchased the product.

**Origin:** RITM OKB ZAO, 99, Petrovskaya, Taganrog, 347900, Russia.

**Model:** RITMSCENAR Super Pro v.2.

**Classification:** *Type of protection against electric shock* – Internally powered equipment (4 batteries each of 1.5 V) *Applied parts* – Type BF.

**Waterproofing:** **No special protection against liquid ingress provided (IPX0).**

**Cleaning & Disinfecting:** Wipe electrode area with a cotton swab dampened with 3 % hydrogen peroxide solution with the addition of 0.5 % solution of an approved cleaning liquid. Allow to dry up thoroughly before use. Clean case of device and add-on electrodes with a damp (not soaking) cloth and mild soap solution. Allow to dry before use.

Do not sterilize SCENAR device and add-on electrodes.

Do not expose any part of SCENAR device and add-on electrodes to chemical solvents or harsh cleaning fluids. Follow cleaning instructions in this manual.

**Clinical environment:** NOT suitable for use in the presence of flammable anaesthetic mixtures with air, oxygen or nitrous oxides.

**Add-on electrodes:** Only add-on electrodes supplied by the manufacturer can be used. They are suitably for electromagnetic emitting suppressing.





**DO NOT DISASSEMBLE the device – this can be done by special service personnel only.**

**Batteries:** Remove batteries from the device if not in use for an extended period. Connect correctly. **DO NOT TRY TO RECHARGE** disposable batteries! Dispose of used batteries responsibly. Use good quality, within-date long-life, 1.5 V ALKALINE Type LR03 (AAA) batteries.

***Note** Total batteries removal should be used during storage and transportation to avoid battery drain.*

*The device should NOT be operated with the battery cover removed, as this exposes the operator to battery circuits in contravention of the Safety Regulations.*

**MARKS AND SYMBOLS ON THE DEVICE CASE**

	<p><b>THIS CE SYMBOL CERTIFIES THAT THE PRODUCT COMPLIES WITH THE ESSENTIAL REQUIREMENTS OF THE MEDICAL DEVICE DIRECTIVE</b></p> <p><b>Notified Body No.2265 3EC International a.s., Hraničná 18, Bratislava, 82105, Slovakia</b></p>
	<p><b>APPLIED PARTS – TYPE BF</b></p>
 <p>RITM OKB ZAO 99 Petrovskaya Str, Taganrog, 347900, RUSSIA 2012</p>	<p><b>MANUFACTURER combined with DATE OF MANUFACTURE</b></p>
<p><b>SN-XXXX</b></p>	<p><b>SERIAL NUMBER</b></p>
	<p><b>CONSULT INSTRUCTIONS FOR USE</b></p>
	<p><b>AUTHORISED REPRESENTATIVE IN THE EUROPEAN COMMUNITY</b></p>

# CONTENTS

- MARKS AND SYMBOLS ON THE DEVICE CASE..... 4**
- 1 PURPOSE ..... 6**
- 2 SPECIFICATIONS..... 6**
- 3 DELIVERY SET ..... 12**
- 4 DEVICE COMPONENTS AND CONTROLS ..... 12**
- 5 PREPARING DEVICE FOR OPERATION..... 14**
- 6 USING THE DEVICE..... 15**
  - 6.1 GENERAL INSTRUCTIONS..... 15**
  - 6.2 MAIN MENU ..... 18**
    - 6.2.1 Setting the Dose (Dose)..... 18
    - 6.2.2 Setting the Amplitude Modulation (AM). ..... 22
    - 6.2.3 Setting the Frequency Modulation (FM). ..... 23
    - 6.2.4 Setting the Damping mode (Dmp) ..... 23
    - 6.2.5 Setting the Frequency (F) ..... 23
    - 6.2.6 Setting the Intensity (Int)..... 24
    - 6.2.7 Setting the Stimulus Gap in a Burst (Gap)..... 24
    - 6.2.8 Switching Off the Device..... 24
    - 6.2.9 Switching the Device to the Standby Mode ..... 24
  - 6.3 SERVICE MENU..... 26**
    - 6.3.1 Setting the Automatic Turn-Off Time (AOff)..... 26
    - 6.3.2 Setting the Backlight Time (Lght)..... 27
    - 6.3.3 Setting the Screen Contrast (Cont)..... 27
    - 6.3.4 Setting the Default Screen Direction (Save Scr)..... 27
    - 6.3.5 Setting the Language (Lng) ..... 27
    - 6.3.6 Setting the Sound Volume (Snd) ..... 28
    - 6.3.7 Saving the Settings (Write) ..... 28
    - 6.3.8 Reading the Settings (Read)..... 28
- 7 MAINTENANCE SERVICE ..... 28**
- 8 TROUBLESHOOTING ..... 28**
- 9 WARRANTY ..... 30**
- 10 TRANSPORTATION AND STORAGE ..... 31**
- ANNEX 1 ..... 32**

## 1 PURPOSE

**RITMSCENAR Super Pro v.2 transdermal electroneurostimulator** – (hereinafter – the device or SCENAR) – is intended for delivering general therapeutic non-invasive treatment to the physiological systems of the body via human skin areas in order to treat various pathologies.

The device is intended to treat and rehabilitate people and can be used by medical professionals in medical-prophylactic institutions, hospitals, emergency care units as well as at home according to the doctor's prescription.

The device should be used under temperatures between 10 °C and 35 °C with relative humidity not to exceed 80 % at a temperature of 25 °C.

Potential risk from the device usage refers to Class IIa (2a) DIRECTIVE 93/42/EEC (GOST R 31508).

The device complies with the standards EN 60601-1 (GOST R 50267.0) and EN 60601-2-10 (GOST R 50267.10) for internally powered equipment, type BF, which classifies it as a safe device for personal use.

## 2 SPECIFICATIONS

2.1 Supply voltage – from 4 up to 6.4 V (four 1.5 V alkaline batteries).

2.2 Maximum supply current – not greater than 650 mA.

2.3 At a load as shown in Fig.1 SCENAR provides:

2.3.1 two-phase stimuli without a DC-component (see Fig.2) with a waveform depending on the skin impedance under the electrode (see Fig.3 through 5) generated at a fixed frequency that can be controlled within 15 to 350 Hz  $\pm$  5 %.

2.3.2 control of the stimulus' 1<sup>st</sup> phase duration (see Fig.2) within  $(4 \pm 2)$  to  $(500 \pm 50)$   $\mu$ sec, and the amplitude of the first pulse of the stimulus 2<sup>nd</sup> phase at L1 load as shown in Fig.1 varies from  $(1.7...2.5)$  V to  $(100...150)$  V;

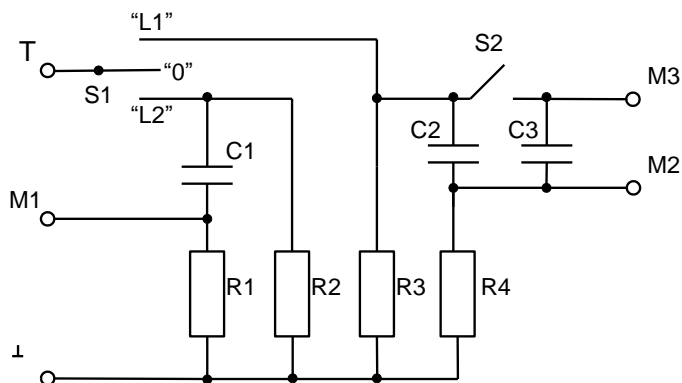

- C1                    K73-11-630V-2200 pF ± 10 %
- C2, C3                K73-11-250V-0.033 μF ± 10 %
- R1                     1/4W 11 kΩ ± 5 %
- R2, R3                1/4W 91 kΩ ± 5 %
- R4                     1/4W 560 Ω ± 5 %

M1...M3 are measuring points

Fig.1

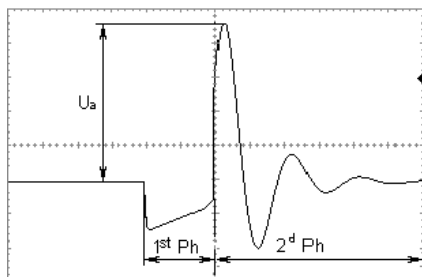

1<sup>st</sup> Ph – stimulus' 1<sup>st</sup> phase duration  
 2<sup>d</sup> Ph – stimulus' 2<sup>nd</sup> phase duration  
 U<sub>a</sub> – stimulus' 2<sup>nd</sup> phase 1<sup>st</sup> pulse amplitude

Fig.2

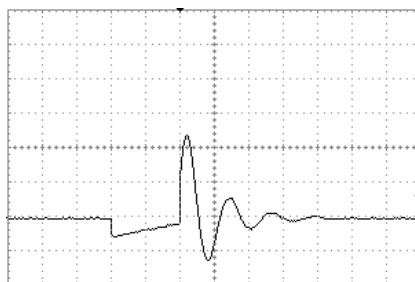

Load L1; S2 – 'Off',  
 load capacity – 33 nF

Fig.3

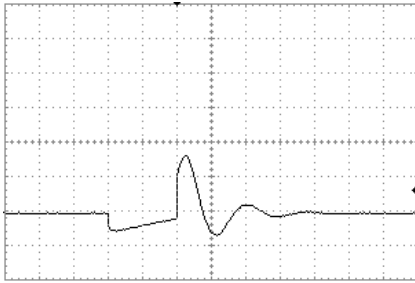

Load L1, S2 – ‘On’,  
load capacity – 66 nF

Fig.4

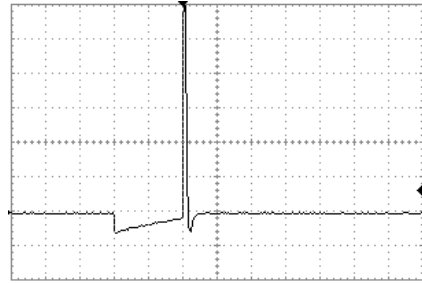

Load L2,  
load capacity – 2.2 nF

Fig.5

2.3.3 Amplitude modulation (see Fig.6) with the following settings:

- ◆ pause time:  $(1.0 \pm 0.5)$  sec;
- ◆ stimulus burst time:
  - in the 1:1 mode –  $(1.0 \pm 0.5)$  sec;
  - in the 2:1 mode –  $(2.0 \pm 0.5)$  sec;
  - in the 3:1 mode –  $(3.0 \pm 0.5)$  sec;
  - in the 4:1 mode –  $(4.0 \pm 0.5)$  sec;
  - in the 5:1 mode –  $(5.0 \pm 0.5)$  sec.

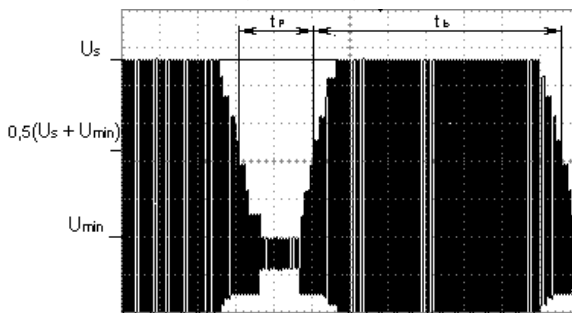

$U_{min}$  – minimum amplitude  
 $U_s$  – set amplitude

$t_p$  – pause time  
 $t_b$  – stimulus burst time

Fig.6

2.3.4 BEE mode – generation of a single stimulus with the first pulse of the 2<sup>nd</sup> phase having the highest amplitude;



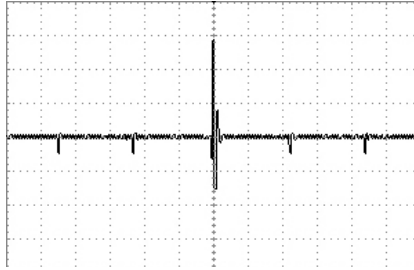

Fig.7

2.3.5 Frequency modulation (variable frequency) with the following settings:

- ◆ variation range – 30 to 120 Hz ± 5 %;
- ◆ variation period – (7 ± 2) sec;

2.3.6 Damping modes (change of influencing stimulus' initial shape):

- ◆ **Dmp Off** (no damping) (see Fig.8);
- ◆ **Dmp Sc1** (weak damping) (see Fig.9);
- ◆ **Dmp Sc2** (moderate damping) (see Fig.10);
- ◆ **Dmp Sc3** (strong damping) (see Fig.11);
- ◆ **Dmp Sc4** (maximum damping) (see Fig.12);
- ◆ **Dmp Var** – variable damping with the following settings:
  - ◇ damping variation range: from **Dmp Off** to **Dmp Sc4** and back;
  - ◇ period of damping variation: (7.5 ± 2.0) sec.

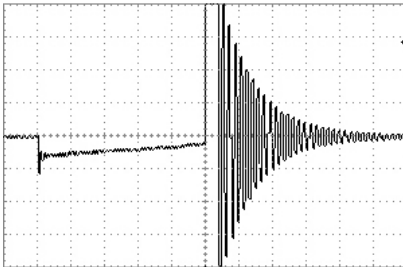

Fig.8

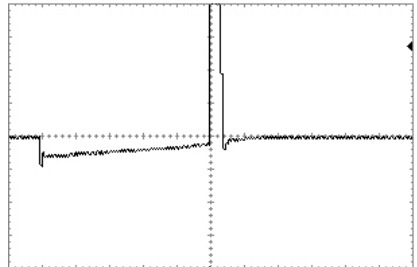

Fig.9

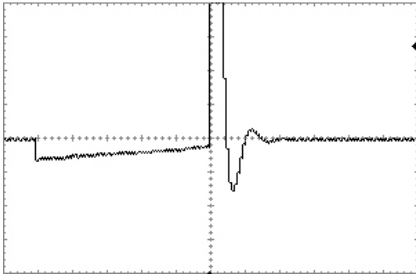

Fig.10

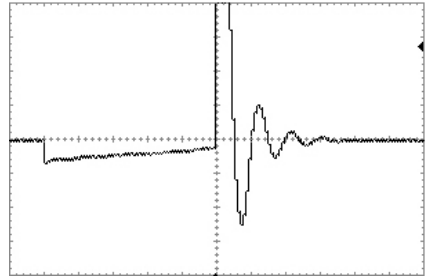

Fig.11

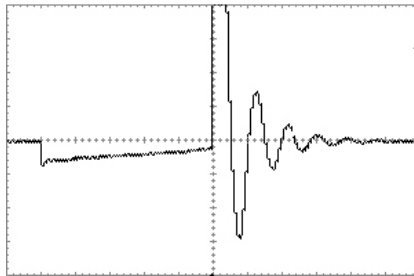

Fig.12

2.3.7 Generation of stimulus bursts. The number of stimuli in a burst – intensity – is controlled within 1 to 8 at a step of 1, and the pause between stimuli in a burst – (between the end of the 1<sup>st</sup> phase of the current stimulus and the beginning of the 1<sup>st</sup> phase of the following stimulus, called **Gap**) – from  $(200 \pm 10)$  to  $(1600 \pm 100)$   $\mu\text{sec}$ ;

2.3.8 Combined modulation (swing) modes:

2.3.8.1 **Sw1** with the following settings:

- ◆ frequency modulation according to p.2.3.5;
- ◆ variable damping according to p.2.3.6;
- ◆ intensity 3;
- ◆ gap continuously changes from  $(200 \pm 10)$  to  $(1600 \pm 100)$   $\mu\text{sec}$  and back.

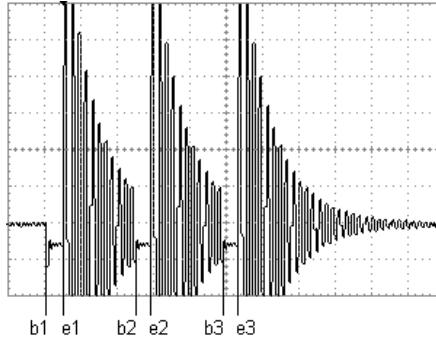

b1, b2, b3 – beginning of the 1<sup>st</sup> phase of stimuli  
 e1, e2, e3 – end of the 1<sup>st</sup> phase of stimuli

Fig.13

2.3.8.2 **Sw2** with the following settings:

- ◆ frequency modulation according to p.2.3.5;
- ◆ variable damping according to p.2.3.6;
- ◆ intensity 3;
- ◆ gap randomly changes from  $(200 \pm 10)$  to  $(500 \pm 25)$   $\mu\text{sec}$ .

2.3.8.3 **Sw3** with the following settings:

- ◆ frequency modulation according to p.2.3.5;
- ◆ variable damping according to p.2.3.6;
- ◆ intensity 3;
- ◆ gap randomly changes from  $(200 \pm 10)$  to  $(1460 \pm 100)$   $\mu\text{sec}$ .

2.3.8.4 **Sw4** with the following settings:

- ◆ frequency modulation according to p.2.3.5;
- ◆ variable damping according to p.2.3.6;
- ◆ intensity randomly changes from 1 to 4;
- ◆ gap continuously changes from  $(200 \pm 10)$  to  $(1600 \pm 100)$   $\mu\text{sec}$  and back.

2.3.9 (Optional) Automatic modulation with the following settings:

- ◆ intensity automatically changes from 1 to 7;
- ◆ gap automatically changes from  $(200 \pm 10)$  to  $(1600 \pm 100)$   $\mu\text{sec}$ ;
- ◆ frequency:
  - is set manually from 15.3 to 90.7 Hz;
  - or
  - is set automatically from 60 to 350 Hz.

- 2.4 Device's weight – not greater than 0.4 kg.
- 2.5 Overall dimensions – not greater than 190×70×40 mm.
- 2.6 Average nonfailure operating time – not less than 1000 hours.
- 2.7 Average service life – not less than 5 years.

### 3 DELIVERY SET

SCENAR complete delivery sets are given in Table 1:

Table 1

Article	Quantity (units)
RITMSCENAR Super Pro v.2	1
Local electrode	1
Alkaline battery AAA type	4
Cover	1
Operating Manual	1
Instruction for Use	1

Note:

- 1) On the customer's request, the electro-neurostimulators can be completed with the following add-on electrodes:
  - Face electrode
  - Comb electrode
  - Point electrode
  - Special Snail electrode
  - Bent point electrode
  - Double facial Pawns electrode
  - Double cosmetic electrode
  - Double ophthalmic Goggles electrode
  - Double facial Stamps electrode
  - Single ophthalmic Monocle electrode
  - Special double Pencils electrode
  - Large comb electrode
  - Multi-purpose zonal electrode
- 2) Add-on electrodes listed in p.1) can be purchased on the customer's request at extra cost.

## 4 DEVICE COMPONENTS AND CONTROLS

4.1 The device is illustrated in Fig.14. The device has an upper cover 1 with a screen 8, case with a built-in electrode 9 and a battery cover 2. All components except for the batteries are located on the printed circuit board inside the device's case.

4.2 The LCD screen 8 displays the results of measuring, settings and device's state.

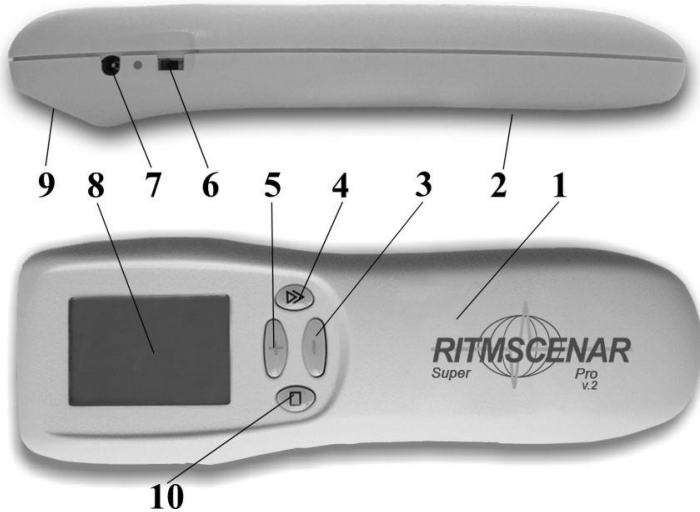

Fig.14

4.3 The device has the following controls on the upper side 1 of its case:

- ◆ button 3 (−) – is used to decrease the energy strength or value of a selected parameter;
- ◆ button 4 (↕) – is used to select parameters and exit the standby mode;
- ◆ button 5 (+) – is used to increase the energy strength or value of a selected parameter;
- ◆ button 10 (□) – is used to rotate the picture on the screen.

4.4 The lateral surface of the case has a switch button 6 to switch on/off the device and plug 7 for connecting add-on electrodes.

4.5 The device is powered from 4 alkaline batteries (AAA Type).

## 5 PREPARING DEVICE FOR OPERATION

5.1 Before every procedure disinfect electrodes with a cotton wad wetted in a 3 % hydrogen peroxide solution with the addition of 0.5 % solution of an approved cleaning liquid. Allow to dry up thoroughly before use. Clean case of device and add-on electrodes with a damp (not soaking) cloth and mild soap solution. Allow to dry before use.

5.2 Open the battery compartment cover and install the batteries. Switch the device on using the switch button on the lateral panel. A message containing the information about the device's name, version and its software release date (Fig.15) will be displayed for 2 seconds and a beep will sound.

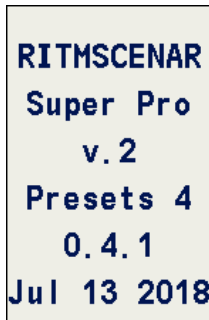

Fig.15

5.3 Then the device switches to the state that displays **basic parameters** (hereinafter called '**B' state**'). So, the basic parameters of stimulation will be displayed (Fig.16).

The first line contains the timer, indicator of the device's contact with the patient's skin (● – contact, ○ – no contact), and a battery charge indicator. **The timer is reset upon pressing any button, and when automatic turn-off is enabled, the timer is reset on contacting the skin as well.**

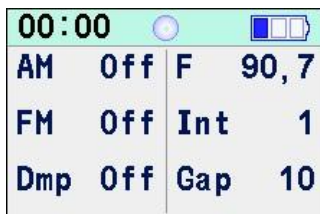

Fig.16

5.4 Press the ▾ button to switch to the **Menu state** (Fig.17). Press the ▾ button at an interval of no longer than 2 seconds to make sure that the highlighting switches cyclically.

Then wait until the device switches to the '**B' state** (this will happen in 2 seconds after the latest pressing of the button ▾), then press the – button once. A long (1 sec) beep will sound.

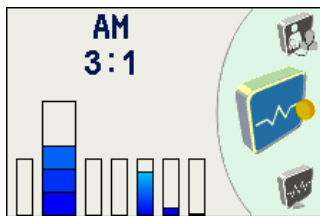

Fig.17

Press and hold the button +. The number in the right part of the top line will be changing from 1 to 250, and then a long beep will sound.

If you performed all the operations mentioned above in this item and the device works as described, the device is ready to be used for therapy. Otherwise, refer to the Chapter 8 (Troubleshooting).

5.5 Switch off the device using the switch button.

## 6 USING THE DEVICE

### 6.1 GENERAL INSTRUCTIONS

6.1.1 When manipulating the device, observe the indications on the screen and beeping.

6.1.2 A chart of the device’s basic states is illustrated in the Fig.18 (dotted lines mean that the **Dose** is on).

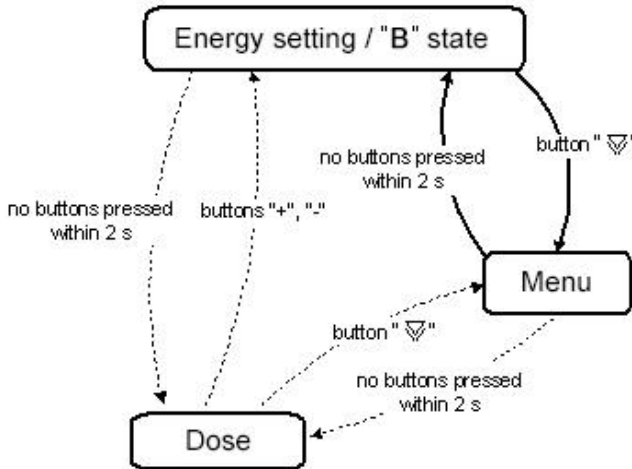

Fig.18

After being switched on, the device is always in the **'B' state**. In the **'B' state** the device will stimulate at the settings displayed on the screen. Use the **+** and **-** buttons to control the energy strength of stimulation. Use the **▽** button to switch the device to the **Menu state**.

In the **Menu state** you can set all parameters except for the energy strength. For detailed description of these parameters see the items 6.2.1-6.2.9. A current parameter is highlighted inversely. Use the **+** and **-** buttons to change the current parameter’s value. Use the **▽** button to move down the menu, use the **□** button to move up the menu. If no buttons are

pressed within 2 seconds, the device will switch to the **'B' state**, or, if any dosing is on, the device will switch to the **Dose state**.

To activate the dosing, set the **Dose** parameter to **1, 2, 3, 4, or 5** in the menu.

In this state pressing the **+** and **-** buttons switches the device to the **'B' state** to control the energy value (the device will return to the **Dose state** if no buttons are pressed within 2 seconds).

To switch the device to the **Menu state**, use the button  $\nabla$ .

6.1.3 The device supports 4 screen orientations: 2 landscape modes (Fig.19a) and 2 portrait modes (Fig.19b). To change the screen orientation, press the  $\square$  button in the **'B' state** or in the **Dose state**.

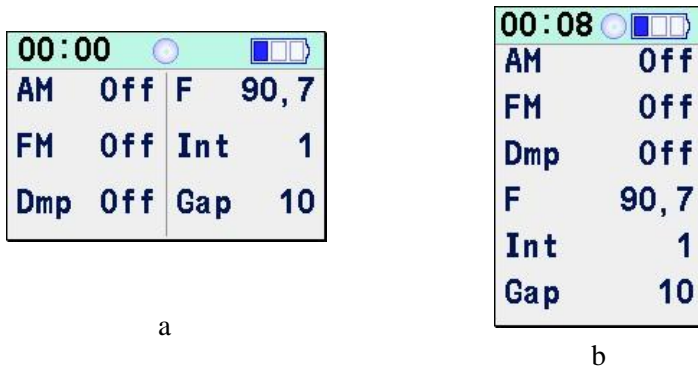

Fig.19

6.1.4 There is a battery indicator in the top line of the screen. The degree of its infill shows the battery's charge. If the indicator is blank, remove **all 4 batteries and install 4 new ones**.

6.1.5 When switching on the device, the following parameters are set:

- ◆ the energy strength of stimulus is set to the minimum setting (**1**);
- ◆ dosing is switched off (**Off**);
- ◆ amplitude modulation is switched off (**Off**);
- ◆ frequency modulation is switched off (**Off**);
- ◆ stimulus frequency is set to **90.7** Hz;
- ◆ damping is switched off (**Off**);
- ◆ intensity is set to the minimum setting (**1**);
- ◆ gap between stimuli in a burst is set to the minimum value (**10**).



**Attention!** *To avoid painful sensations when treating the most sensitive areas on the patient's body, it is recommended that the energy strength is decreased to minimum before the treatment by pressing and holding the **−** button until a long beep sounds).*

6.1.6 Apply the electrode on the skin on the zone to be treated. The ● symbol will be displayed on the screen indicating that the electrode is contacting the skin. Make sure that patient isn't experiencing unpleasant sensations. Press and hold down the **+** button till the first sensation like pricking, light burning or vibrations appear. They shall be sensed as comfortable and not painful, but must be felt on the skin.

**Attention!** *When using add-on electrodes, connect electrode cable only to the switched-off device, in order to prevent the device damage and to avoid painful sensations!*

6.1.7 To start therapy, set the required mode. Then put the electrode on the skin area to be treated (see the Instruction for Use provided with your device).

6.1.8 To treat auricular zones and acupuncture points, connect your add-on point electrode to the appropriate jack. Make sure of the contact by touching the skin with the electrode. Before every treatment of any acupuncture point, dip the end of the probe in water to wet the surface.

Stimulation by point electrode that is too small or by any electrodes that applied incorrectly could result in discomfort.

**Note** *When using add-on electrodes, especially point and comb, the dosing mode can be out-of-work even in case of good contact with skin and even if the patient feels the stimulation. **It is not a fault.***

In the **'B'** state the **+** and **−** buttons are used to control the energy strength within the range from 1 to 250 units. To control the energy strength you can either press the buttons 'step by step' or press and hold the appropriate button (this way is faster, 16 steps per second). When the energy strength reaches the value that cannot be further increased/decreased, the device will indicate it with a long beep.

6.1.9 If the automatic turn-off is enabled (see p. 6.3.1), and if there is no contact with the skin for 30 seconds, the device will automatically switch to the standby mode. This will be accompanied by a beep, text message and screen darkening. To resume SCENAR operation, press the  button.

## 6.2 MAIN MENU

### 6.2.1 Setting the Dose (Dose)

When **Dose Off** is set (which is indicated by a long beep), the Dosing is off.

**Dose 1** (indicated by a short beep) activates the **individually-dosed mode** (hereinafter – **IDM**) with the adaptive integral criterion of delivered stimulation (**Dose**) and integral criterion of achieving the null relative dynamics (**Zero**).

**Dose 2** (indicated by 2 short beeps) activates **IDM** with the differential criterion of achieving the null dynamics (Differential Dose).

**Dose 3** (indicated by 3 short beeps) activates the **Screening mode** (for searching the optimal treatment places).

**Dose 4** (indicated by 4 short beeps) is similar to **Dose 3** but the data are displayed in the circle (when the screen image is horizontal).

Optional **Dose 3** and/or **Dose 4** modes can represent the labile screening mode data (for searching skin areas with maximal reaction in a labile mode): current reaction to the initial reaction ratio in the audiovisual mode.

**Dose 5** (indicated by a dual-tone beep) is used to carry out electropunctural diagnostics in 24 points (6 points on each extremity) with an add-on local electrode.

**When switching between dose modes, damping switches off automatically.**

After **Dose 1** or **Dose 2** has been selected, if no buttons are pressed within 2 seconds, the device will switch to the **Dose state** (Fig.20).

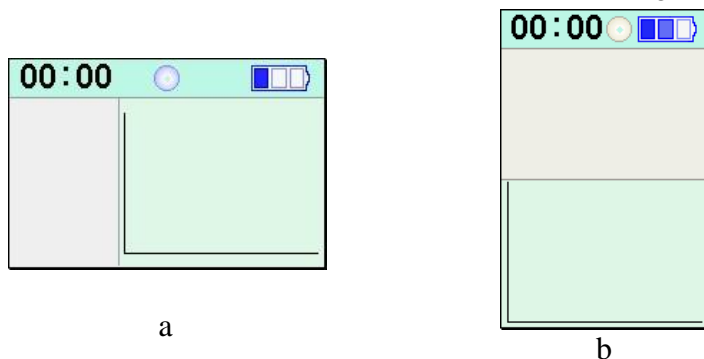

Fig.20

Once the device detects that the electrode is contacting the skin, the device will give a short low pitch signal (○ will change to ● in the top line), and in a second it will give a short high pitch signal and the screen will display (both digitally and graphically) the results measured over the first second (the diagram will show current (ongoing) reaction change with time).

After 1 second more, measurement results for the 2<sup>nd</sup> second will be displayed on the screen. Then, **current** results of measuring (time, reaction, rate of reaction change, shape factor) illustrated in the Fig.21 will be updated every second, and the diagram will be filled up. It will continue this way until either **Dose** or **Zero** is achieved.

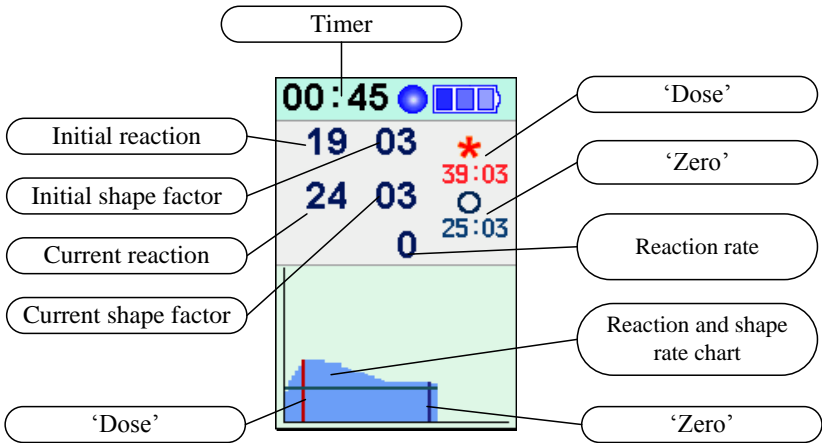

Fig.21

In **Dose 1**, until **Dose** is delivered, the device emits beeps indicating the time elapsed from the moment the electrode contacted the skin. At the 10<sup>th</sup> second the device emits one short beep, at the 17<sup>th</sup> sec – two beeps, at the 24<sup>th</sup> sec – three beeps, and so on – n beeps at the (3+7\*n) second.

When the **Dose** is reached it is simultaneously indicated by:

- 2-second dual-tone beep and;
- the \* symbol displayed along with the values of the reaction and shape factor registered at a point of the Dose (in red).

When the **Zero** is reached it is simultaneously indicated by:

- series of low pitch sounds during 2 seconds;
- the ○ symbol displayed along with the values of the reaction and shape factor registered at a point of the Zero (in blue).

Once you take the device up from the skin, ● will change to ○ in the top line, and all other information will stay the same on the screen.

In the **Dose state**, pressing any button resets the timer and measurements. Moreover, touching the skin with the electrode also resets the timer.

When switching on **Dose 3**, **Dose 4**, and **Dose 5**, all modulations and damping are switched off forcibly.

Data displayed on the screen at **Dose 3** are shown in Fig.22, and those for **Dose 4** are illustrated in Fig.23. In these modes after 1-second stimulation a short beep will sound, the energy strength will decrease to the minimal level, and the device will be waiting for the electrode to be taken off from the skin. Once the electrode is taken off, the previously set value of the energy is restored.

Successively applying the device on the points to be treated, you can get up to 8 results of initial measurements on the screen.

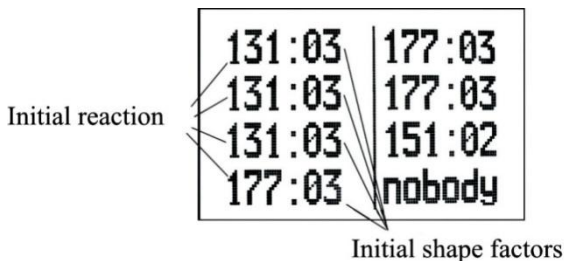

Fig.22

Every next measuring, its results are displayed in the next line. For **Dose 3** the results of the 8<sup>th</sup> measuring will be displayed in the 8<sup>th</sup> line, and those of the 9<sup>th</sup> measuring will be displayed again in the in the 8<sup>th</sup> line. So, all previous lines will as if move one line upwards. So, in the **Dose 3** screening mode, the screen displays the results of initial measurements for the latest 8 points.

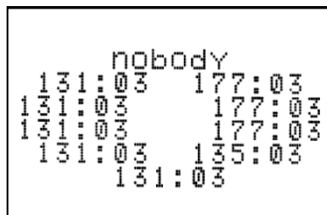

Fig.23

In **Dose 4** horizontal and vertical data display are different.

For horizontal display (Fig.23), measurements are displayed in a circle clockwise, beginning from the upper position (10 positions in all).

The results of the 11<sup>th</sup> measurement will be displayed in the position of the first measurement, and so on.

For vertical display, measurements are displayed in a column like in **Dose 3**, but the data of 16 measurements are displayed and they remain in their constant positions.

(Optional) **Dose 3** and/or **Dose 4** modes can represent the labile screening mode data (for searching skin areas with maximal reaction in a labile mode): current reaction to the initial reaction ratio in the audiovisual mode:

The current to the initial reaction ratio	Indication
ratio < 1/2	no indication by color
1/2 <= ratio < 1	one stripe (blue) displayed
1 <= ratio < 1 1/2	Two stripes (blue+green) displayed
1 1/2 <= ratio < 2	Three stripes (blue+green+yellow) displayed and the device emits a single beep every second
2 <= ratio	Four stripes (blue+green+yellow+red) displayed and the device emits double beep every second

Moreover, if the current reaction exceeds the previous maximum, this is indicated by a **clicking sound**.

**Attention!** *In fact there is a double indication: a relative value of current reaction to initial one – in the screen and by sounds, and an absolute maximum of reaction – by **clicks**.*

**Dose 5** is intended for estimating the state of 24 meridians that make 12 pairs. In this case a special local electrode shall be used (Fig.24).

The energy strength shall be set **before** switching to **Dose 5** as it cannot be changed in this mode.

When **Dose 5** is switched on, the screen will display a matrix of 24 values in 4 columns: 6 – for the left hand, 6 – for the right hand, 6 – for the left foot, and 6 – for the right foot. The columns are named respectively: LH, rH, lF, rF (Fig.25). In this mode the picture on the screen cannot be rotated.



Fig.24

To select a point to be measured, use **+** and **-** buttons (the selected point will be highlighted). The measurement is made during 1 sec after the electrode contacts the skin, and the measured value appears in the highlighted matrix entry, and the energy strength decreases to the minimum. Once the electrode is taken off from the skin, the previously set value of the energy is restored.

To view the measurements as a graph (Fig.26), press  button. To return to the matrix, press the button once again.

To quit **Dose 5**, press  button.

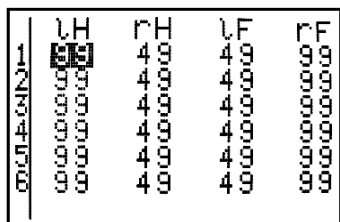

Fig.25

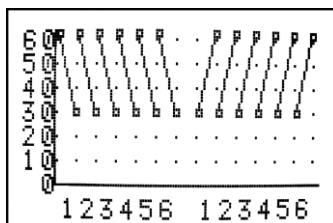

Fig.26

For detailed description of treatment in Dosing modes see recommendations for treating in the individually-dosed mode in the Instruction for Use provided with your device.

### 6.2.2 Setting the Amplitude Modulation (AM)

The amplitude modulation modes are the following:

- ♦ continuous mode (**AM Off**) is indicated by a long beep;
- ♦ mode **AM 1:1**: pause – 1 sec, pulses – 1 sec, the mode is indicated by a short beep;
- ♦ mode **AM 2:1**: pause – 1 sec, pulses – 2 sec, the mode is indicated by two short beeps;
- ♦ mode **AM 3:1**: pause – 1 sec, pulses – 3 sec, the mode is indicated by three short beeps;
- ♦ mode **AM 4:1**: pause – 1 sec, pulses – 4 sec, the mode is indicated by four short beeps;
- ♦ mode **AM 5:1**: pause – 1 sec, pulses – 5 sec, the mode is indicated by five short beeps;
- ♦ mode **AM**: generation of a single stimulus with the highest amplitude, indicated by a dual-tone beep.

### 6.2.3 Setting the Frequency Modulation (FM)

The frequency modulation modes are the following:

- ◆ fixed frequency mode (**FM Off**). Activating the mode is indicated by a long beep;
- ◆ variable frequency mode (**FM On**). Activating the mode is indicated by a dual-tone beep. In this mode **the device ignores the settings of the F parameter**;
- ◆ Swing 1 combined modulation mode (**FM Sw1**). The mode is indicated by a low pitch beep. At the same time the **device forcibly sets the following parameters: Dmp, Int, Gap, F**. After you activate the **Sw1** mode, you can change the settings of the **Dmp** parameter. The settings that cannot be changed are marked with asterisk on the screen (Fig.27);
- ◆ Swing 2 combined modulation mode (**FM Sw2**). The mode is indicated by 2 low pitch beeps;
- ◆ Swing 3 combined modulation mode (**FM Sw3**). The mode is indicated by 3 low pitch beeps;
- ◆ Swing 4 combined modulation mode (**FM Sw4**). The mode is indicated by 4 low pitch beeps.

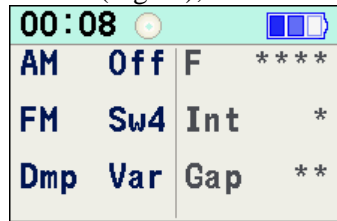

Fig.27

### 6.2.4 Setting the Damping mode (Dmp)

The Damping modes are the following:

- ◆ Damping Off (**Dmp Off**) is indicated by a long beep;
- ◆ Damping 1 (**Dmp Sc1**) is indicated by a short beep;
- ◆ Damping 2 (**Dmp Sc2**) is indicated by 2 short beeps;
- ◆ Damping 3 (**Dmp Sc3**) is indicated by 3 short beeps;
- ◆ Damping 4 (**Dmp Sc4**) is indicated by 4 short beeps;
- ◆ Variable damping (**Dmp Var**) – is indicated by a two-tone beep.

### 6.2.5 Setting the Frequency (F)

6.2.5.1 To control the frequency, you can either press the buttons ‘step by step’ or press and hold the appropriate button (this way is faster).

Frequency can be controlled within the range 15 (**15.6**) to 350 (**354**) Hz step by step at a step of about 2 % of the current frequency

value (128 steps in all). When the maximum or minimum frequency is reached, the device emits a long beep.

In addition, reaching the frequencies of **30.5, 59.6, 90.7, 119** and **181** Hz is indicated by 1, 2, 3, 4, and 5 short beeps respectively. While the beeps sound, the frequency cannot be changed. This makes it easier to set the required frequency.

### 6.2.6 Setting the Intensity (Int)

The intensity (the number of stimuli in a burst) can be controlled within the range of 1 to 8 but the maximum intensity value depends on frequency, gap, and energy strength. The greater the frequency, gap and energy strength are, the smaller maximum intensity you can set. For example, at a maximum frequency (**354** Hz) the intensity cannot be greater than 2.

With increased frequency, gap or energy strength, the intensity is automatically decreased when needed.

When the intensity is more than 1 apart from the main frequency (which can be set in the item '**F**' of the Main Menu), an additional (equivalent) frequency appears, which is higher than the set one and depends on the stimuli energy and Gap, see Table 2.

The intensity of the additional (equivalent) frequency in relation to the main directly depends on the item **Intensity** of the Main Menu.

(Optional) The device can indicate the equivalent frequency during the energy level tuning.

### 6.2.7 Setting the Stimulus Gap in a Burst (Gap)

To control the gap, you can either press the buttons 'step by step' or press and hold the appropriate button (this way is faster).

At **Int 1**, the **Gap** parameter has no sense, though it can still be controlled, and then, when you will be increasing the intensity, the device will use the set value of the gap.

### 6.2.8 Switching Off the Device

To switch off the device, use the switch button on the lateral surface of the case. The settings are NOT SAVED after switching off but you can save your 5 sets of parameters in the flash memory of the device (see p. 6.3.6).

### 6.2.9 Switching the Device to the Standby Mode

To switch the device to the standby mode, press simultaneously the buttons  and . To resume operation, press the button .



Table 2.

		Energy												
Gap	1	2	5	10	20	30	50	80	100	150	200	250		
10	4950	4902	4762	4545	4167	3846	3333	2778	2500	2000	1667	1429		
11	4505	4464	4348	4167	3846	3571	3125	2632	2381	1923	1613	1389		
12	4132	4098	4000	3846	3571	3333	2941	2500	2273	1852	1563	1351		
13	3817	3788	3704	3571	3333	3125	2778	2381	2174	1786	1515	1315		
14	3546	3521	3448	3333	3125	2941	2632	2273	2083	1724	1471	1282		
15	3311	3289	3226	3125	3941	2778	2500	2174	2000	1667	1429	1250		
20	2488	2475	2439	2381	2273	2174	2000	1786	1667	1429	1250	1111		
30	1661	1656	1639	1613	1563	1515	1429	1316	1250	1111	1000	909		
40	1247	1244	1235	1220	1190	1163	1111	1042	1000	909	833	769		
50	998	996	990	980	962	943	909	862	833	769	714	667		
60	832	831	826	820	806	794	769	735	714	667	625	588		
70	713	712	709	704	694	685	667	641	625	588	556	526		
80	624	623	621	617	610	602	588	568	556	526	500	476		

## 6.3 SERVICE MENU

The device has a **Service menu state** (Fig.28).

To enter the Service menu, press the buttons  $\nabla$  and  $+$  simultaneously, and a rising beep will sound. Optionally, devices may have an additional way to enter service menu by pressing and holding  $\nabla$  button. The parameters of the Service menu are selected and set in the same way as in the main Menu (to select a parameter, use the buttons  $\nabla$  and  $\square$ , and to set the required value, use the buttons  $+$  and  $-$ ). When no buttons are pressed within 2 seconds, the device switches to the previous state, and the **value of the highlighted parameter** (and this value solely) is saved in the flash memory of the device. If the value has been changed, then a descending beep will sound.



Fig.28

So, within the same menu entering, you can **change any number of parameters but only one parameter will be saved.**

### 6.3.1 Setting the Automatic Turn-Off Time (AOff)

The **AOff** menu item enables or disables automatic turn-off of SCENAR.

When the **AOff** is set to **Off**, the automatic turn-off is disabled. (**Attention! This may cause faster battery exhaustion when you leave the device switched on for a long time.**)

When the **AOff** is set to **On**, then when no buttons are pressed and no contact with the skin has been detected within 30 sec, SCENAR will switch to the standby mode (see p.6.1.9).

If **AOff** is set to **5m (10m or 20m)**, then when no buttons pressed and no contact with the skin has been detected within 30 sec, SCENAR will also switch to the standby mode. Moreover, in the **Dose 0** mode SCENAR will switch to the standby mode in 5 (10 or 20) minutes even if

there was a contact with the skin. This mode is intended to treat one point for a specified time.

***Attention!*** *In the ‘AOff Off’ and ‘AOff 5m’ (10m or 20m) modes, taking the electrode up from the skin as well as pressing any button resets the timer.*

The differences of the automatic turn-off modes are given in the Table 3.

Table 3

Automatic turn-off time when no buttons pressed

<b>AOff</b>	<b>No contact</b>	<b>Contact</b>	<b>Timer reset</b>
<b>Off</b>	never	never	never (only when buttons pressed)
<b>On</b>	30 sec	never	Every time the electrode contacts / is taken up from the skin
<b>5m</b>		5 min	
<b>10m</b>		10 min	
<b>20m</b>		20 min	

### 6.3.2 Setting the Backlight Time (Lght)

The **Lght** menu item is the time of screen backlighting for the following events – pressing any button, reaching the **Dose** or **Zero**, expiration of the first second of measuring in the **Dose state** or expiration of every 30 seconds.

### 6.3.3 Setting the Screen Contrast (Cont)

The **Cont** menu item allows to control the picture contrast.

### 6.3.4 Setting the Default Screen Direction (Save Scr)

The **Save Scr** menu item allows to save the current direction of the picture on the screen as default.

### 6.3.5 Setting the Language (Lng)

The **Lng** menu item allows to select a language (two languages are available – **Russian** and **English**).

### 6.3.6 Setting the Sound Volume (Snd)

The **Snd** menu item is for volume control. When **Snd 0** is set, all sounds except for clicks while controlling the energy strength will be disabled, and in the '**B**' state a corresponding icon will be displayed in the top line of the screen (Fig.29). **Snd 1** is for minimum sound volume, **Snd 2** – for medium volume, and **Snd 3** – for maximum volume.

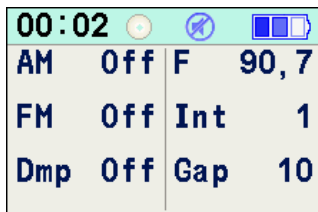

Fig.29

### 6.3.7 Saving the Settings (Write)

The **Write** menu item allows to save up to 5 sets of parameters (**Dose, AM, FM, Dmp, F, Int, and Gap**). To save your sets of parameters in one of 5 cells, select the cell number and wait until the device exits the Service menu. A descending beep will indicate that the settings have been saved.

### 6.3.8 Reading the Settings (Read)

The **Read** menu item allows to read the earlier saved sets of parameters from the non-volatile memory (see p.6.3.7). Select the number (**1...5**) of the cell that contains your presets saved earlier and wait until the device exits the Service menu.

Optionally, devices may include up to 32 factory presets which, as compared to user presets, cannot be amended by a user and are indicated by the names instead of numbers. A descending beep will sound and the settings will be applied. And the energy strength will be automatically set to minimum.

## 7 MAINTENANCE SERVICE

The device shall be serviced and repaired only by the manufacturer.

## 8 TROUBLESHOOTING

8.1 If the device is not operating properly, identify the problem and refer to the following trouble shooting chart for suggested solutions as indicated in the following Table 4.

Table 4

<b>Fault</b>	<b>Possible cause</b>	<b>Troubleshooting method</b>
Some adjustments do not work or the requirements of p.5.4 are not fulfilled.	Processor mal-function.	Switch off the device, and in 5-10 sec switch it on again. Check whether the requirements of p.5.4 are fulfilled. If the problem persists, contact the manufacturer.
<p>The SCENAR device emits 5 short beeps from time to time.</p> <p>The picture on the LCD disappears or is distorted from time to time.</p> <p>The SCENAR device fails to switch ON.</p>	The batteries are discharged or set incorrectly.	Check and replace the batteries. If the problem persists after the batteries are replaced, contact the manufacturer.
The SCENAR device operates but there is no energy on the built-in electrode.	<p>The protective film is not removed from the built-in electrode.</p> <p>The energy level is too low.</p>	<p>Remove the protective film from the built-in electrode.</p> <p>Increase the energy level until comfortable sensations appear.</p>
There is no energy on the add-on electrode, while the energy on the built-in electrode is felt.	<p>The add-on electrode malfunction.</p> <p>There is no contact between the plug and jack.</p> <p>The incompatible add-on electrode.</p>	<p>Replace the electrode.</p> <p>Check the connection between the add-on electrode plug and the SCENAR device jack.</p> <p>Use only the add-on electrodes supplied by the manufacturer of the SCENAR device.</p>

Continue table 4

Fault	Possible cause	Troubleshooting method
There is no energy both on the add-on and built-in electrodes when the add-on electrode is connected, but the energy on the built-in electrode is felt when the add-on electrode is not connected.	Short circuit in the add-on electrode cable or plug.  The incompatible add-on electrode.	Replace the electrode.  Use only the add-on electrodes supplied by the manufacturer of the SCENAR device.
The SCENAR device turns off when there is a skin contact.	Bad skin contact or the skin is very dry.	Check the settings of the <b>AOff</b> . Refer to item 6.3.1.

8.2 Other malfunctions shall be repaired only by the manufacturer.

## 9 WARRANTY

9.1 The manufacturer guarantees that the device complies with this document when operated properly.

9.2 Warranty period is 24 months from the date of purchase.

9.3 In case of malfunction during the warranty period the device with this Operating Manual shall be returned to the manufacturer.

9.4 The warranty repair is not performed in case of device’s Operating Manual absence or broken seals.

9.5 The device is repaired at the expense of the owner in the following cases:

- ◆ the device was operated improperly;
- ◆ the manufacturer’s seals are broken;
- ◆ mechanical damage to the device;
- ◆ the warranty period expired.

9.6 Customer claims are rejected if:

- ◆ the product has been subjected to any mechanical damage resulting from an accident, fire, acts of nature, or acts of God;
- ◆ the manufacturing serial numbers, labels, seals are damaged or removed, or any other labeling identifying the product is damaged or removed;

- ◆ the seals are broken or the product contains any other signs of unwarranted access (repair);
- ◆ the product contains the defects resulting from:
  - ◇ inappropriate transportation and storage conditions (no original package during the transportation, hyperhumidity, aggressive environment, any signs of foreign objects, animals and insects, effect of liquid, etc.);
  - ◇ inappropriate treatment (overload, mechanical, thermal or electric damages, bent contacts, cracks, spalling, dints and impact marks, completely or partially changed shape of the device);
- ◆ using low quality or inappropriate accessories.

## **10 TRANSPORTATION AND STORAGE**

10.1 The transportation of the devices to a customer is carried out by all kinds of covered vehicles, except the plane compartments that have no heating, at the air temperature from  $-50$  to  $+50$  °C and relative humidity not to exceed 100 % at a temperature of 25 °C with a protection from a direct atmospheric precipitation.

10.2 After transportation at negative temperatures, the device should be kept in the transport container under normal climatic conditions for not less than 24 hours.

10.3 The device shall be stored in the manufacturer's package in a heated room, under the air temperature of 5 °C to 40 °C and relative humidity not to exceed 80 % at a temperature of 25 °C.

## ANNEX 1

<b>Guidance and manufacturer's declaration – electromagnetic compatibility (EMC)</b>		
<b>Intended healthcare environment – Professional</b>		
<b>Emissions</b>		
Classification		—
Standard	EN 55011 (idt CISPR 11)	
Class A or B	B	—
Group 1 or 2	1	—
Conducted RF Emissions		N/A NOTE 1
Radiated RF Emissions		PASS
Disturbance Power (if applicable)		N/A NOTE 2
Harmonic Distortion per EN 61000-3-2 (Class A, B, C, D)		N/A NOTE 1
Voltage Fluctuations and Flicker per EN 61000-3-3		N/A NOTE 1
<b>Immunity</b>		
Electrostatic Discharges EN 61000-4-2		PASS
Radiated RF EM Fields and Proximity Wireless fields EN 61000-4-3		PASS
Electrical Fast Transients and bursts EN 61000-4-4		N/A NOTE 3,4
Surges EN 61000-4-5		N/A NOTE 3,5
Conducted Disturbances, induced by RF fields EN 61000-4-6		N/A NOTE 3,4
Voltage Dips and Interruptions EN 61000-4-11		N/A NOTE 1
Rated Power-frequency Magnetic Field EN 61000-4-8		PASS
Supplementary information: NOTE 1) EUT is powered by internal batteries 6V DC NOTE 2) If applicable Radiated RF Emissions, Disturbance Power is not necessary NOTE 3) The test is applicable to all d.c. power PORTS intended to be connected permanently to cables longer than 3 m.		



**Guidance and manufacturer's declaration –  
electromagnetic compatibility (EMC)**

NOTE 4) SIP/SOPs whose maximum cable length is less than 3m in length are excluded.

NOTE 5) This test applies only to output lines intended to connect directly to outdoor cables.

**Guidance and manufacturer's declaration –  
electromagnetic immunity**

<b>Immunity test</b>	<b>EN 60601-1-2 test level</b>	<b>Compliance level</b>
Electrostatic discharge (ESD) EN 61000-4-2	± 8 kV contact ± 2 kV, ± 4 kV, ± 8 kV, ± 15 kV air	PASS
Radiated RF EM fields EN 61000-4-3	3 V/m 80 MHz to 2.7 GHz 80 % AM at 1 kHz	PASS
Enclosure port immunity EN 61000-4-3	EN 60601-1-2:2015 Table 9	PASS
Power frequency (50/60 Hz) magnetic field EN 61000-4-8	30 A/m	PASS